

CLASSIC 1 group



Ref602645 (UCLASSIC1_110VUL)

Traditional espresso maker, 1 group, 6.3 liter boiler, 4 programmable dosing program, manual steam & water, automatic cleaning cycle, stainless steel body

General Features

Traditional single group espresso maker with large steam boiler. Elegant lines and reliable technologies appreciated by coffee professionals, the CLASSIC model is made more attractive by its quality/ price ratio. Designed for rugged commercial application, the CLASSIC is the perfect traditional espresso machine to ensure an excellent quality espresso result, consistency and high performance during rush period.

CLASSIC 1 group

Main Features

- Maestro brew group: directly to boiler group heads are mounted for shot temperature stability.
- Large cup warming capacity: integrated cup warmer on the top of the machines.
- 4 programmable volume keys per group + Semi-automatic key for each group for manual control.
- Automatic cleaning program.
- The CLASSIC Elegant lines and reliable technologies appreciated by coffee professionals, the CLASSIC model is made more attractive by its quality/ price ratio. The CLASSIC is the perfect traditional espresso machine to ensure an excellent quality espresso result, and consistency even during the busiest periods of the day.
- Heavy duty components and welded construction, a direct mounted boiler group head for thermal stability and reliable extraction, easy access to components for uncomplicated servicability, and unlimited steam.

Construction

- Built-in cup warmer.

Included Accessories

CLASSIC 1 group

Electric

Supply voltage:

602645
(UCLASSIC1_110VUL) 110 V/1N ph/60 Hz

Electrical power, max: 1.7 kW

Plug type:

Water:

Cold water temperature
(min/max): 5 / 60 °C

Key Information:

External dimensions,
Width: 13 1/2" (343 mm)

External dimensions,
Depth: 22 3/8" (568 mm)

External dimensions,
Height: 20" (508 mm)

External dimensions,
Weight: 90 lbs (41 kg)

Net weight: 90 lbs (41 kg)

Shipping width: (500 mm)

Shipping depth: (750 mm)

Shipping height: (840 mm)

Shipping weight: lbs (50 kg)

Shipping volume: 0.3 m³

Certifications



The company reserves the right to make modifications to the products without prior notice. All information correct at time of printing.

2023.09.21

Part of  Electrolux
Professional
Group

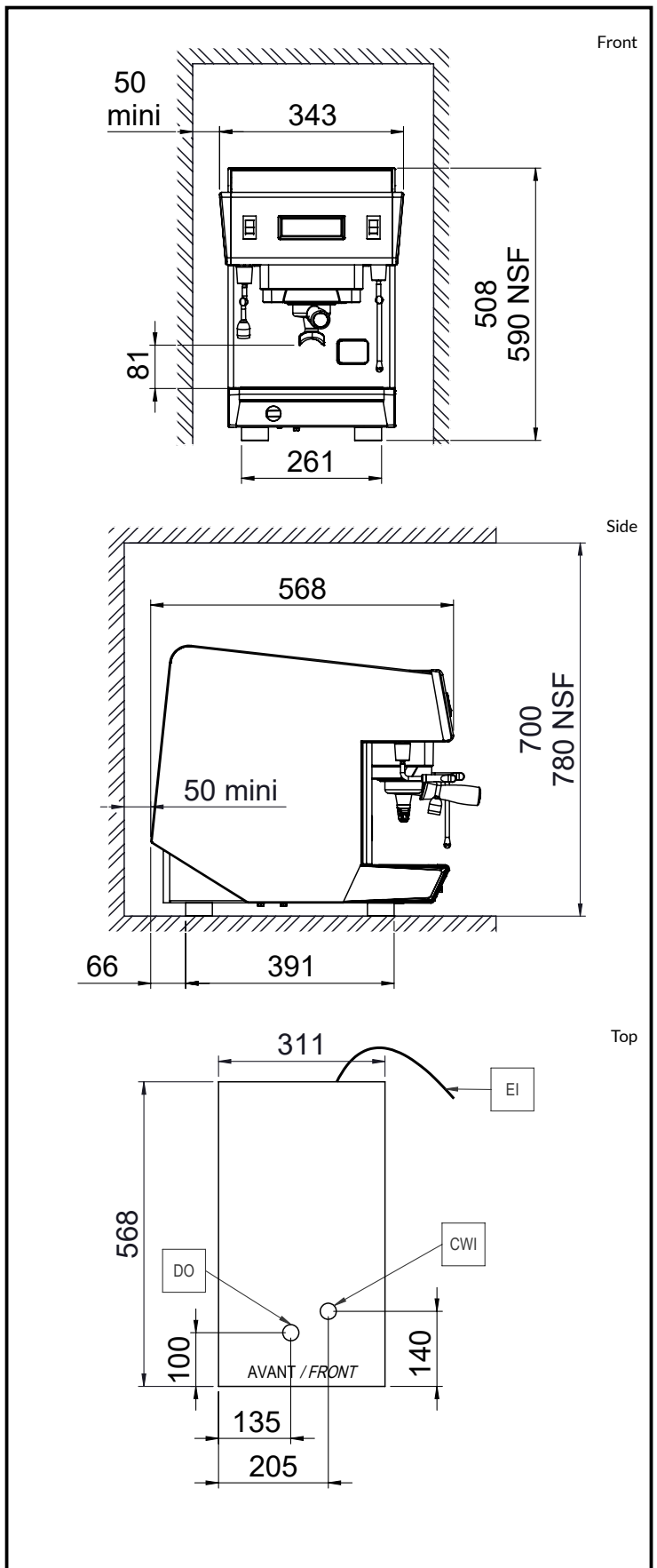

UNIC